

ITEM NO.	PART NUMBER	DESCRIPTION	数量 QTY.
1	OM4-P04-R2	COMPONENT TRAY	1
2	BSOS-M3-6 铆钉	M3 Blind Threaded Standoff	23
3	BSO-M3-8ZI 铆钉	M3 x 8mm Blind Threaded Standoffs	3

REVISIONS				
ZONE	REV.	DESCRIPTION	DATE	APPROVED
	000	INITIAL RELEASE	10-14-2015	
	001	NEW PCB MOUNT POSITIONS	03/21/2016	
	002	NEW COMPONENT TRAY DESIGN	09/28/2016	

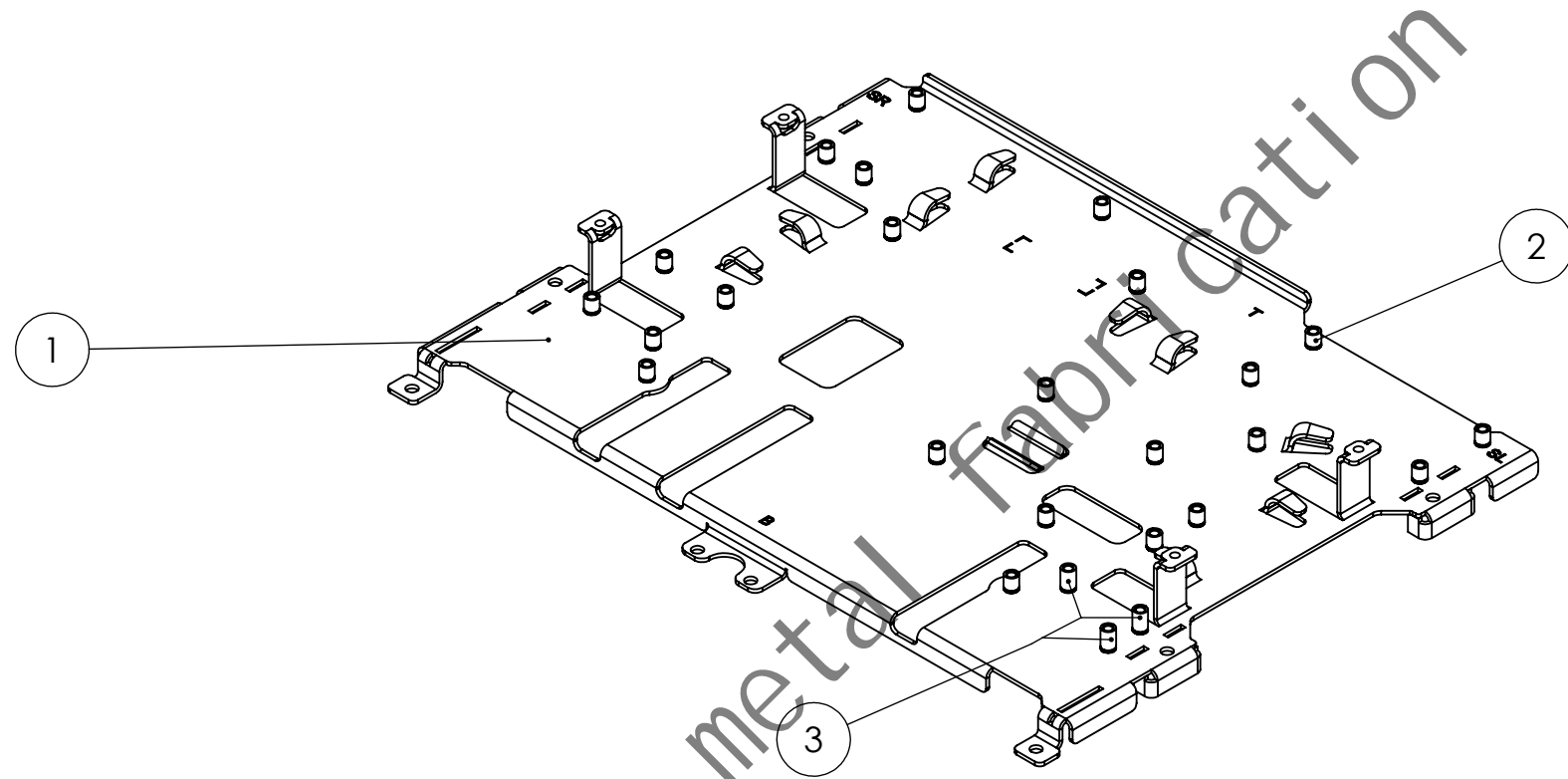

YXPO161063(Candice)11#
材料：1.2mm镀锌钢

表处：无

HSJ metal fabrication

		UNLESS OTHERWISE SPECIFIED:	
		DIMENSIONS ARE IN MILLIMETERS	DRAWN
		TOLERANCES:	CHECKED
		FRACTIONAL ±	ENG APPR.
		ANGULAR: MACH ±.10 BEND ±.10	MFG APPR.
		TWO PLACE DECIMAL ±0.10	Q.A.
		THREE PLAC ±0.105	COMMENTS:
NEXT ASSY	USED ON		
APPLICATION		DO NOT SCALE DRAWING	

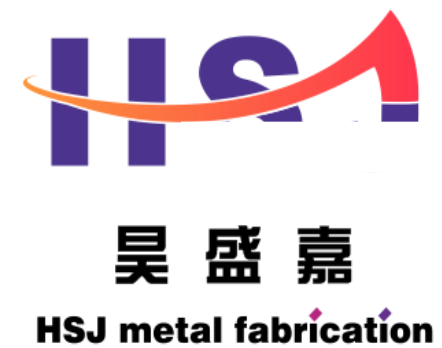

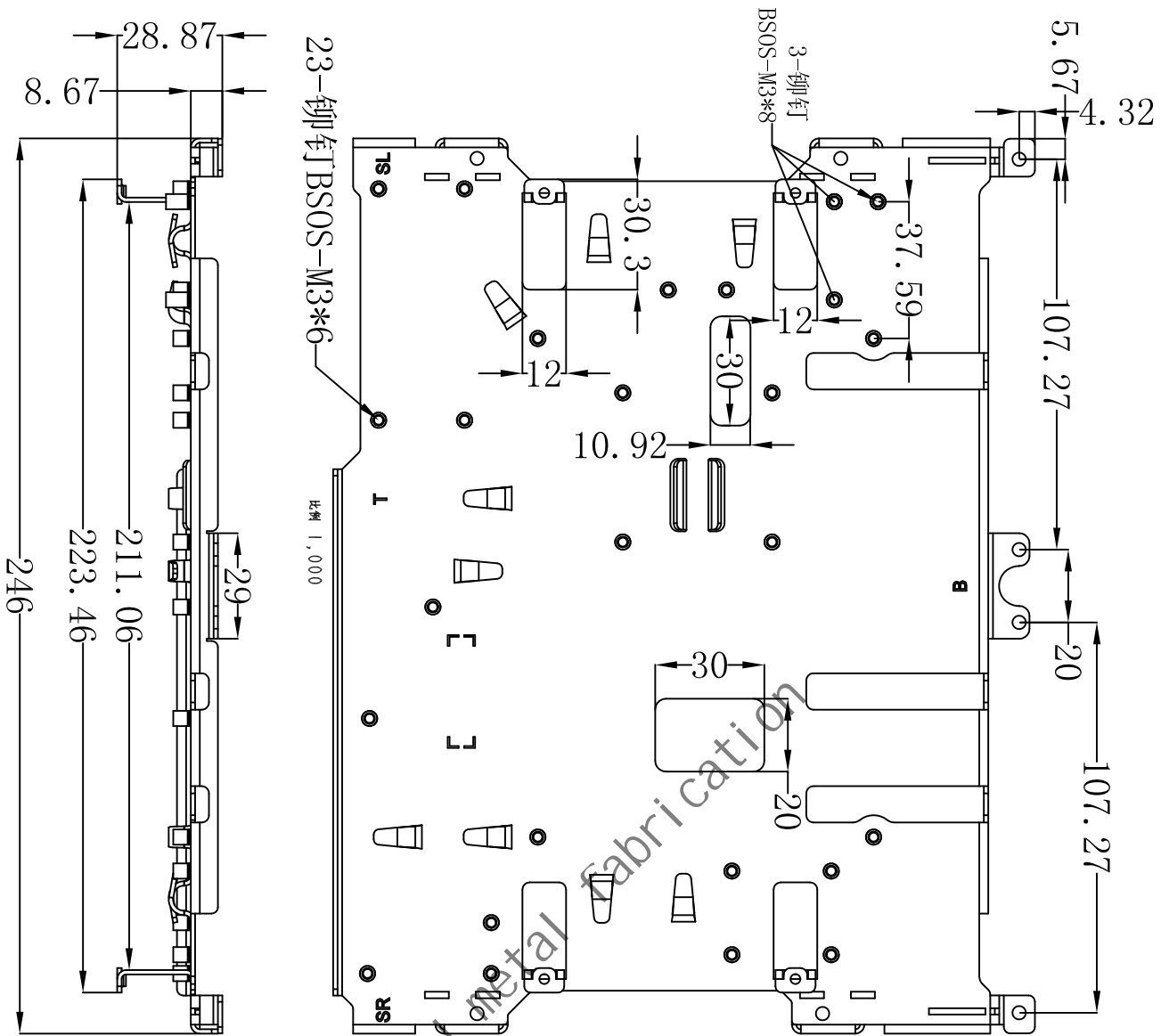

23-铆钉 BSOS-M3*6
比例 1,000

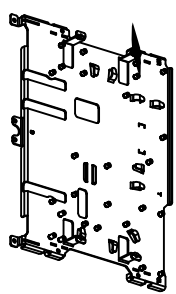
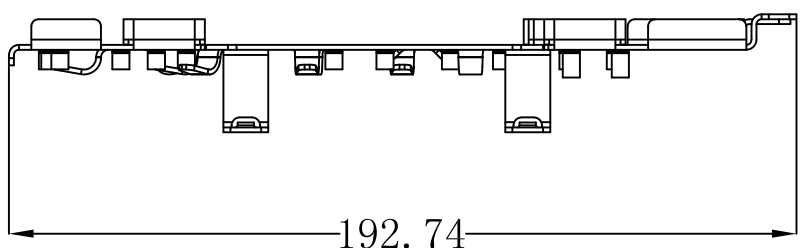

自由公差 Tolerance 自由公差	0-6	±0.05
6-30	±0.1	
30-120	±0.15	
120-400	±0.2	
尺寸范围 角度 (angle)	±0.1°	
尺寸范围 Size range	容许公差 Allowance tolerance	

REVISIONS				
ZONE	REV.	DESCRIPTION	DATE	APPROVED
6A-6D	B	Increase flange height 0.040"	6/24/2015	MBG
5D	C	CHANGE HOLE DIAMETER FROM $\phi .100$ TO $\phi .079$	7/27/2015	MBG
D6	D	REMOVE BENT FLANGE	12/28/2015	MBG
D5	E	CHANGE HOLE DIAMETER TO 0.094	2/29/2016	MBG
C6	F		11/14/2016	MBG

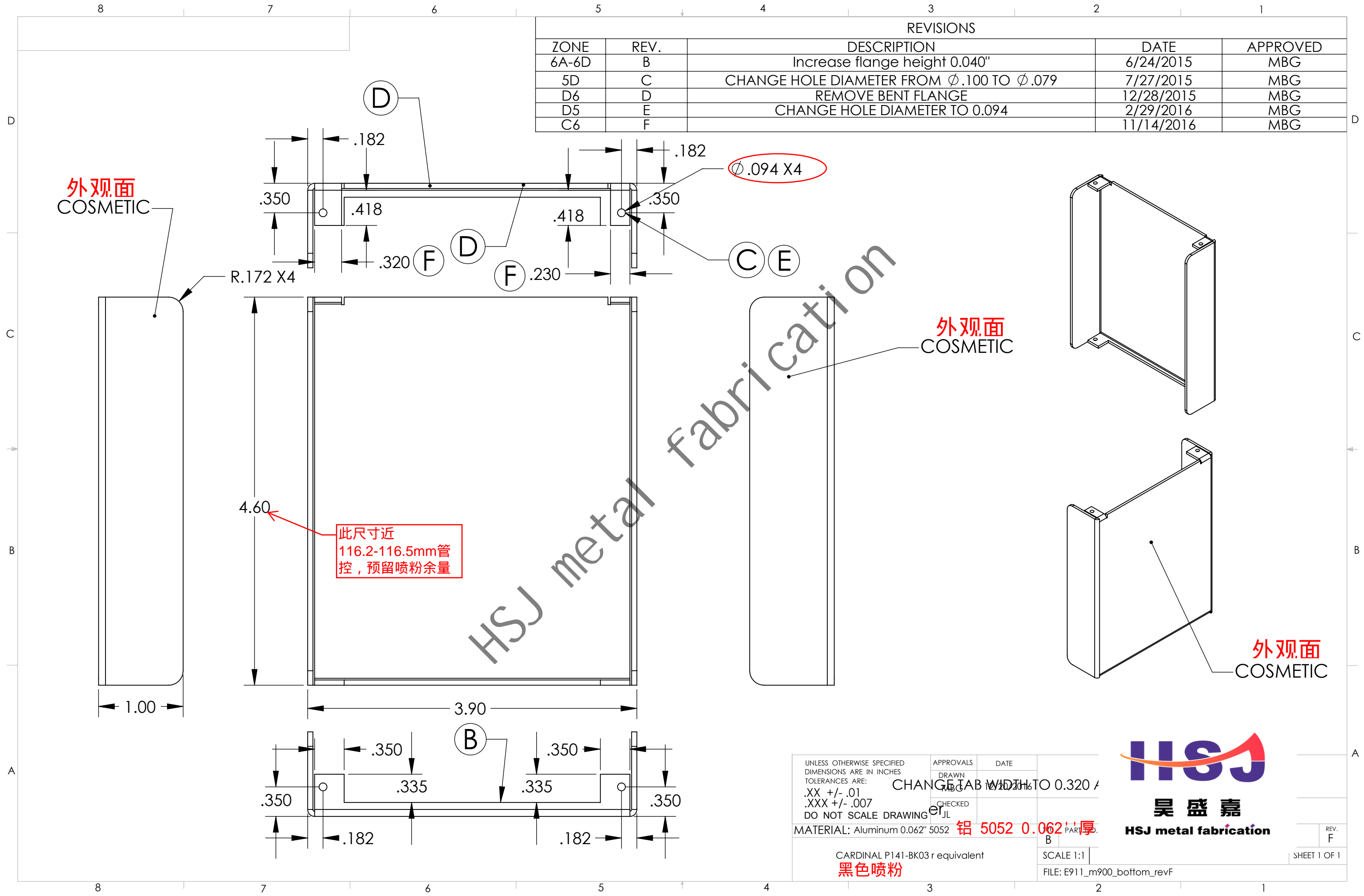

此尺寸近
116.2-116.5mm
管控, 预留喷粉余量

UNLESS OTHERWISE SPECIFIED DIMENSIONS ARE IN INCHES TOLERANCES ARE: .XX +/- .01 .XXX +/- .007 DO NOT SCALE DRAWING	APPROVALS	DATE
	DRAWN MBG	CHANGE TAB WIDTH TO 0.320 /
	CHECKED JL	
	MATERIAL: Aluminum 0.062" 5052 铝 5052 0.062" 厚	
CARDINAL P141-BK03 r equivalent 黑色喷粉		SCALE 1:1
		FILE: E911_m900_bottom_revF

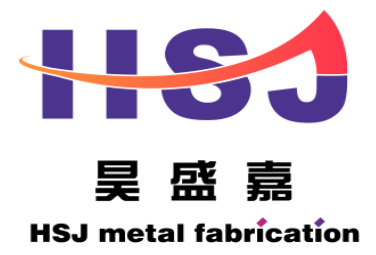

REV. F
SHEET 1 OF 1